

28" Truline Linear Drain Framing Detail Drawing

Front View

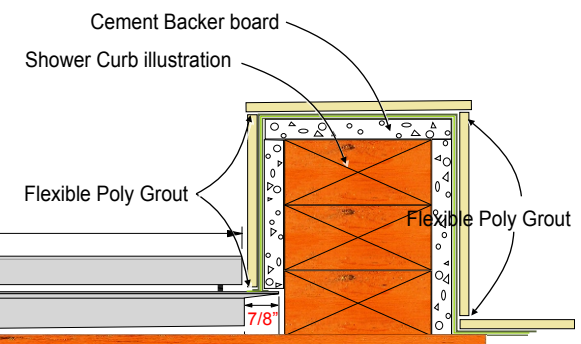
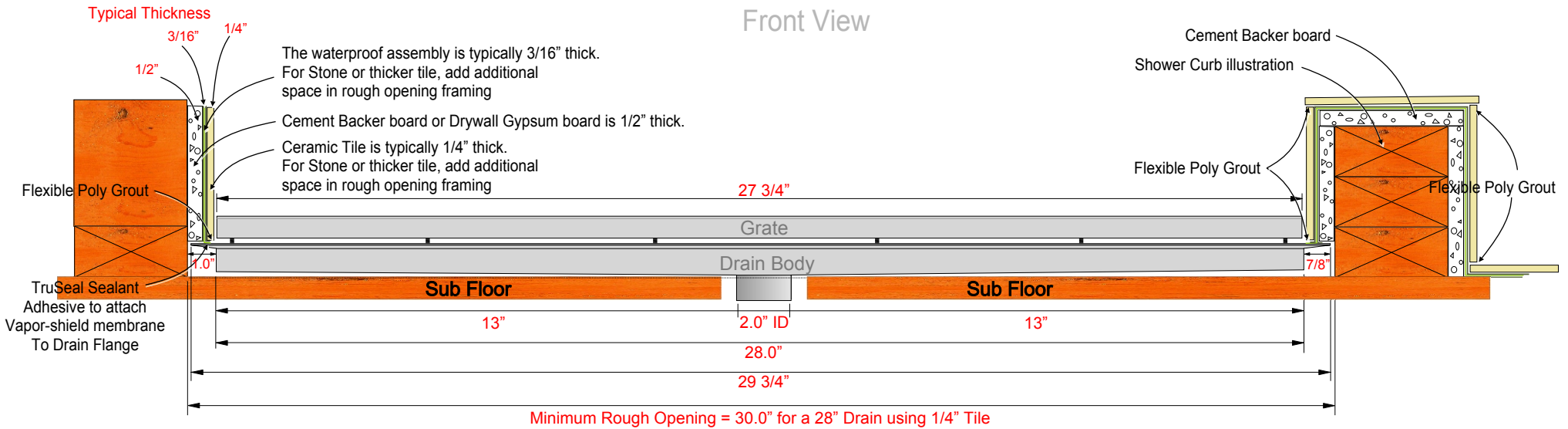

Wall Placement Detail

Side View

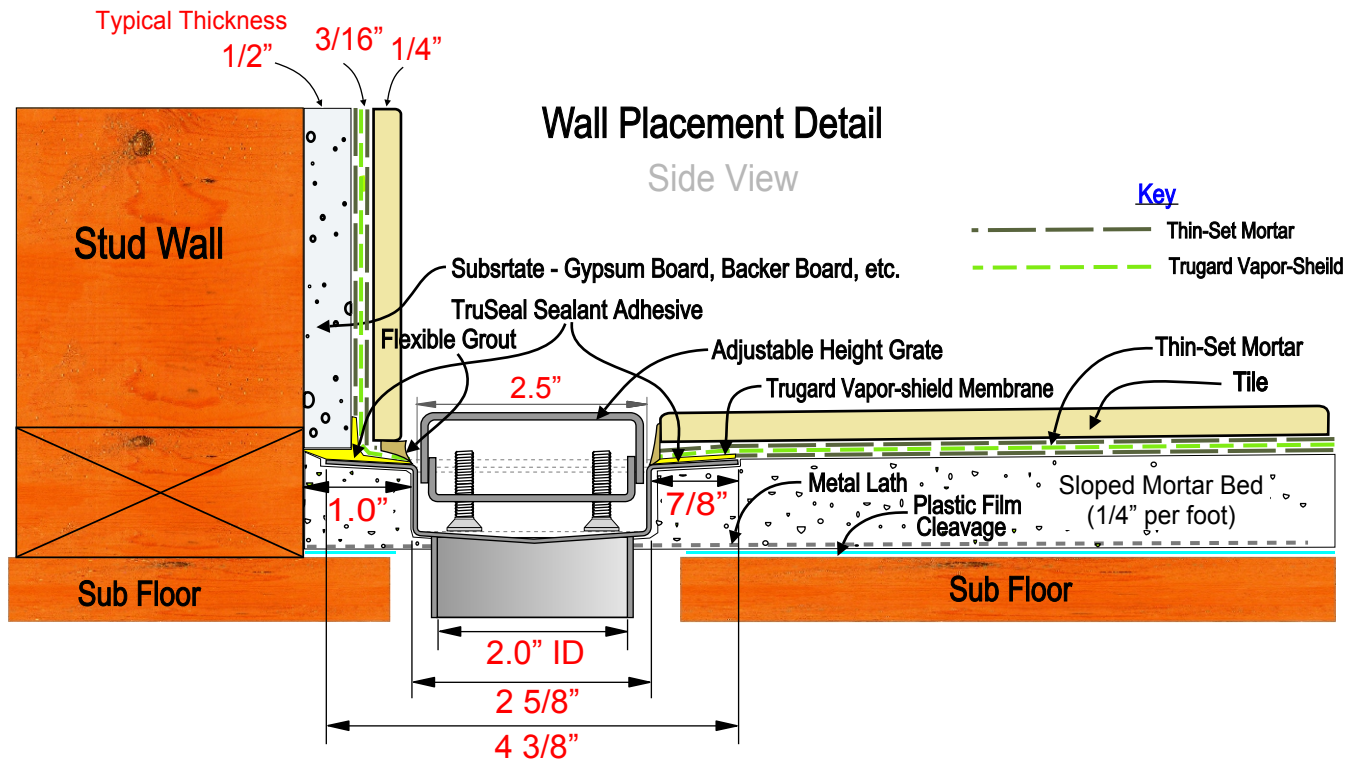

Note: To determine the framing rough opening size, add one inch to the length or width of the drain body, if a one quarter inch thick tile is being used. If the tile or stone is thicker than the 1/4" and the additional thickness of the tile to the 1 inch distance normally used to determine the rough opening size. So for example, for the rough opening for a 28 inch linear drain, the rough opening would need to be 30 inches, when 1/4" tile is being used.